

Description	Specification
External dimensions (height x width)	400 mm
Distance between axis	350 mm
Lenghtways tubes	Extruded alluminium EN AW 6082 T6 - Ø50x2mm
Crossways tubes	Extruded alluminium EN AW 6082 T6 - Ø25x2mm
Connecting plate	Cast alluminium EN AC 42200 T6
Welding process	TIG -141 / ISO 4063
Available lenght (cm)	10 - 25 - 50 - 100 - 150 - 200 - 250 - 300 - 350 - 400
Connection systems	FXFC - FXSM10

Section Area (mm <sup>2</sup> )	Moment of inertia Y - axis (mm <sup>4</sup> )	Moment of inertia Z - axis (mm <sup>4</sup> )	Selfweight (approx.) (N/m)			
603	15.849.600	174.019	30			

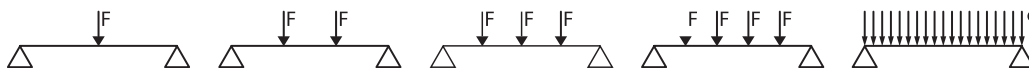

Span [m]	Centre Point Load (C.P.L.)			Third Point Load (T.P.L.)			Quarter Point Load (Q.P.L.)			Fifth Point Load (F.P.L.)			Uniformly Distributed Load (U.D.L.)		
	Point Load [kg]	Full Load [kg]	Central Deflection [mm]	Point Load [kg]	Full Load [kg]	Central Deflection [mm]	Point Load [kg]	Full Load [kg]	Central Deflection [mm]	Point Load [kg]	Full Load [kg]	Central Deflection [mm]	Load [kg/m]	Full Load [kg]	Central Deflection [mm]
1	904	904	0,15	495	990	0,14	346	1038	0,13	267	1070	0,13	1210	1213	0,12
2	620	620	0,80	402	804	0,88	286	858	0,87	223	893	0,87	536	1072	0,86
3	180	180	0,80	117	233	0,88	83	249	0,88	65	259	0,87	104	311	0,86
4	72	72	0,81	46	93	0,88	33	100	0,88	26	103	0,87	31	124	0,86
5	33	33	0,83	21	42	0,88	15	45	0,88	12	46	0,87	11	56	0,86
6	15	15	0,87	9	18	0,87	7	20	0,89	5	20	0,87	4	24	0,86

Load table has been prepared in accordance with UNI ENV 1999-1-1 (Eurocode 9).

When calculating the allowable loads shown in the table, it is assumed that the trusses are simply supported at the end connection and that static loads will be applied to the node points.

The application of the load shall be on the centre line of the truss.

The values shown in the table are the allowable static loads that can be applied to the truss. This is the live load or the payload.

The self weight of the truss has been taken into account when calculating the values in the table.

It should be noted that this are idealised loading conditions and the User shall re-analyze the truss for the loading conditions which prevail for the application being considered.

Date of issue  
31/07/2008

Litec is a Brand of Staging Systems Europe S.p.A.  
www.litectruss.com - info@litectruss.com

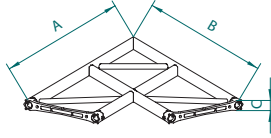

FX40SL2060P

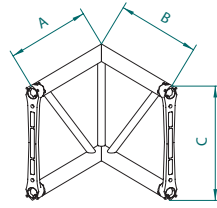

FX40L2060V

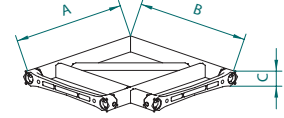

FX40SL2090P

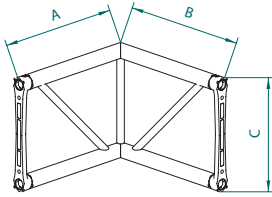

FX40SL2090V

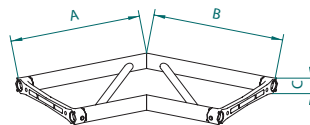

FX40SL2120P

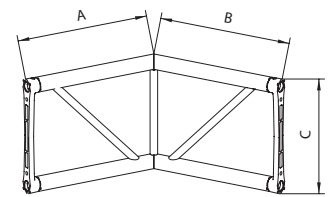

FX40SL2120V

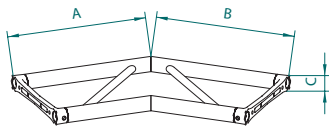

FX40SL2135

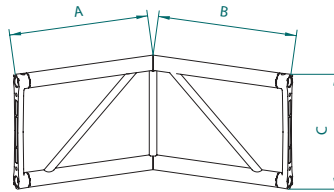

FX40SL2135V

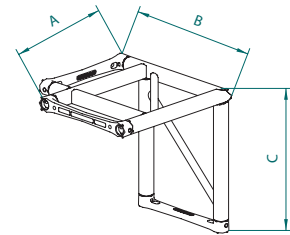

FX40SL3LP

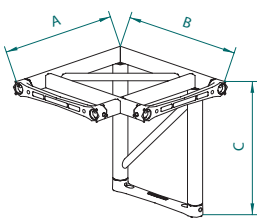

FX40SL3RP

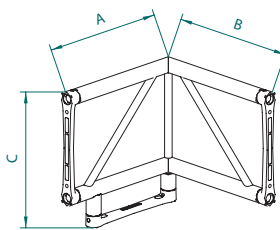

FX40SL3LV

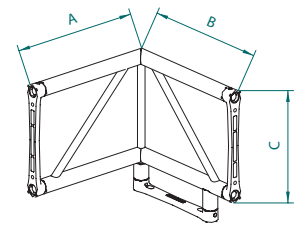

FX40SL3RV

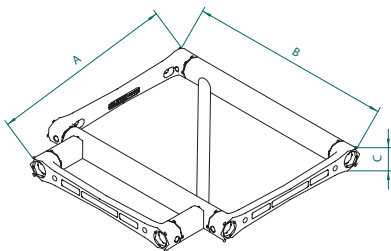

FX40ST3NP

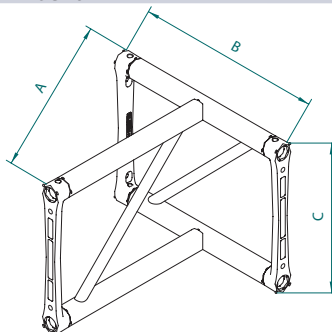

FX40ST3NV

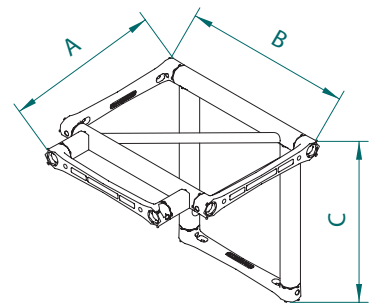

FX40ST4NP

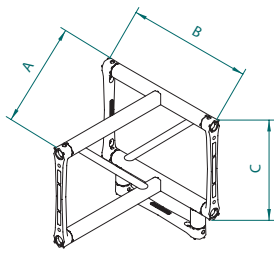

**FX40ST4NV**

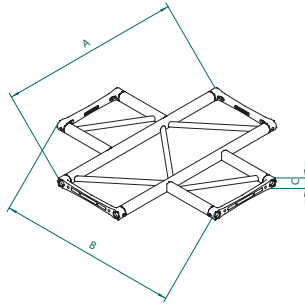

**FX40SX4NP**

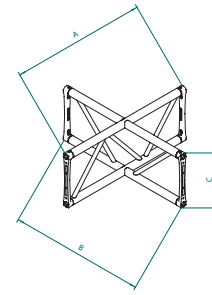

**FX40SN4NV**

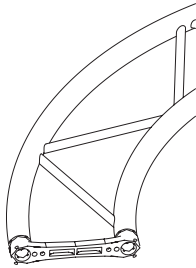

**FX40SFP**



**FX40SFV**

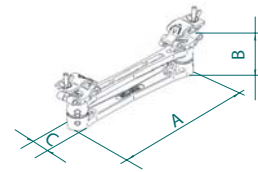

**FX40SAC**

**CORNERS**

Code	D im. (cm) AxBxC	Weight (Kg)
FX40SL2060P	50x50x5	4.50
FX40SL2060V	50x50x40	3.30
FX40SL2090P	50x50x5	2.90
FX40SL2090V	50x50x40	3.30
FX40SL2120P	50x50x5	3.00
FX40SL2120V	50x50x40	3.50
FX40SL2135P	50x50x5	3.50
FX40SL2135V	50x50x40	3.50
FX40SL3LP	50x50x50	4.50
FX40SL3LV	50x50x50	4.10
FX40SL3RP	50x50x50	4.50
FX40SL3RV	50x50x50	4.10
FX40ST3NP	50x50x5	3.10
FX40ST3NV	50x50x50	3.80
FX40ST4NP	50x50x5	4.50
FX40ST4NV	50x50x50	6.20
FX40SX4NP	100x100x5	5.90
FX40SX4NV	50x50x40	6.50
FX40SAC	40x10x5	2.80

**TRUSS**

Code	Dimensions (cm)	Weight (Kg)
FX40S010	40x5x10	1.50
FX40S025	40x5x25	1.80
FX40S050	40x5x50	2.50
FX40S100	40x5x100	3.30
FX40S150	40x5x150	4.30
FX40S200	40x5x200	5.30
FX40S250	40x5x250	6.50
FX40S300	40x5x300	7.20
FX40S350	40x5x350	8.60
FX40S400	40x5x400	9.20

**RINGS**

Curves, rings and ellipses are available on demand

Minimum diameter 2 m

Diameter measurement external

Weight per meter (aprox.) 6Kg